

















Recommended color combinations

Materials	Leatherette ¹		Dakota Leather ²			
	Beige	Black	Cream Beige	Gray	Natural Brown	Black
Upholstery colors³						
Exterior colors⁴						
300 Alpine White Non-metallic		•	•	•	•	•
668 Jet Black Non-metallic		•	•	•	•	•
354 Titanium Silver Metallic			•	•		•
A68 Platinum Gray Metallic			•	•		•
A52 Space Gray Metallic			•	•		•
A53 Platinum Bronze Metallic		•	•	•	•	•
A76 Deep Sea Blue Metallic		•	•	•	•	•
A35 Monaco Blue Metallic		•	•	•	•	•
A43 Deep Green Metallic		•	•	•	•	•
475 Black Sapphire Metallic		•	•	•	•	•
Interior trims						
438 Dark Poplar Wood ⁵						
437 Light Poplar Wood ⁶						
4BY Bamboo Anthracite Wood ⁶						
<p>¹ Standard in 535i xDrive.</p> <p>² Optional in 535i xDrive and included in Premium Package.</p> <p>³ Upholstery and interior colors: Cream Beige Leather upholstery comes with Cream Beige interior color; Beige Leatherette upholstery comes with Beige interior color. Black Leather or Black Leatherette upholstery comes with Black interior color. Natural Brown Leather upholstery comes with Black interior color, which includes a Black/Natural Brown color combination on the door panels, and a Gray headliner. Gray Leather upholstery comes with Gray interior color.</p> <p>⁴ Non-metallic paints are standard; Metallic paints are available at no additional cost.</p> <p>⁵ Standard.</p> <p>⁶ Available at no additional cost.</p>						

■ Standard equipment □ Optional equipment

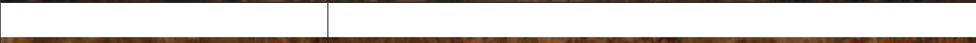
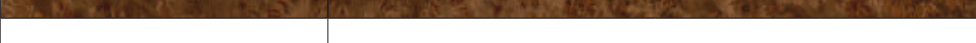

■ **Xenon headlights** provide brilliant clarity of the road ahead and to the side at night and in conditions with poor visibility. **Adaptive Headlights** illuminate the road around corners, using a system that directs the headlights into and through road bends.
□ **High-beam Assistant** automatically turns high beams on and off, as needed, based on light sensor readings.



■ **Adaptive Brake Lights** increase vehicle visibility and signal the intensity of your braking action.



□ **18 x 8.0 Star Spoke (Style 124) alloy wheels with 245/40 run-flat performance tires.**¹
(Requires 535i xDrive Sport Package; spare is a space-saver wheel and tire.)

¹Due to low-profile tires, please note: wheels, tires and suspension parts are more susceptible to road hazard and consequential damages. Performance tires not recommended for driving in ice and snow.



■ **Roof rails** closely hug the lines of the roof. They easily accommodate additional cargo, as well as bicycles, skis, snowboards, etc., when equipped with the multifunctional BMW roof rack system. (Refer to the Original BMW Accessories catalog or visit your authorized BMW center for a full selection.)



■ **17 x 7.5 V Spoke (Style 277) alloy wheels with 225/50 all-season tires.**
(Spare is a space-saver wheel and tire.)

■ Standard equipment

□ Optional equipment



□ **Park Distance Control** uses eight sensors – four in the front, four in the rear – to help you judge how close you are to other cars and unseen objects when parking. While engaged in a parking maneuver, the image on the screen visually changes and warning beeps come faster as the bumper approaches a stationary object, turning into a constant tone when the distance is less than 12 inches.



□ **Active Cruise Control** with Stop & Go uses radar measurements to automatically maintain a preset speed and distance between your vehicle and the one ahead in both heavy traffic and highway driving.² (Requires automatic transmission.)

²Active Cruise Control is not a substitute for the driver's own responsibility in adjusting speed and otherwise controlling the vehicle. After evaluating road, traffic and visibility conditions, the driver decides whether and how the system is used.



■ **BMW Assist™³** and **Bluetooth®** system offers hands-free calling through your BMW-approved **Bluetooth** phone. The BMW Assist Safety Plan is included for four years, providing Automatic Collision Notification.

³The optional Convenience Plan offers Directions, Traffic, Weather, Critical Calling and Concierge services.



□ **20-way power multi-contour front seats⁴** for the driver and front passenger provide optimum lateral support during tight cornering – thanks to specially padded, highly contoured side bolsters – while remaining exceptionally comfortable when driving over long distances. In addition to active head restraints, the seats offer individual power adjustment for backrest and seat-bottom angle; forward/backward and up/down position; thigh, upper back and lumbar support; and adjustable sides.

⁴Multi-contour seats are included in the Sport Package and available as a stand-alone option. Requires optional Dakota Leather upholstery or Premium Package.



■ **Two-piece Panoramic moonroof** features fully electric slide and lift control. Both halves of the roof can be tilted up at the touch of a button. When you tilt the front glass section, the rear section also tilts up electronically. When open, the wind deflector minimizes turbulence. Includes comfort opening/closing function, and an electric sunshade to help shield cabin from excessive heat.



□ **Comfort Access system** offers an even greater degree of convenience: keyless access to your car. Simply carrying the remote key in a pocket allows you to unlock the doors by touching the door handle. You can also turn the engine on or off by pressing the Start/Stop button⁵ without inserting the remote key.

⁵Foot must be on brake, or with manual transmission, brake and clutch must be depressed, in order to start.

■ Standard equipment

□ Optional equipment



■ **3-spoke leather-wrapped multi-function steering wheel** lets you keep both hands on the wheel while adjusting various comfort functions, such as changing the radio, CD selections and volume. Optional Voice Control (included with optional Navigation system) can be used to change radio stations and audio selection, Navigation system destinations, and **Bluetooth®** (if so equipped) telephone entries.



□ **Lane Departure Warning feature¹** alerts the driver by discreetly vibrating the steering wheel if the vehicle crosses lane markings without using the directional signal. (requires Premium Package)

¹Requires clearly definable lane markings that are not obscured by rain, snow, etc. Lane Departure Warning feature is not a substitute for the driver's own responsibility in maintaining safe control of the vehicle.



□ **Navigation system** covers the U.S. with a single DVD. The glare-free monitor is mounted neatly into the dashboard for easy viewing. Using GPS satellites and DVD technology, a map of your area appears on the dash monitor, showing – and telling – the directions to your desired destination. It also provides Real Time Traffic Information on potential traffic problems and solutions.



□ **Head-up Display** projects important travel information – such as current speed – on the windshield directly in the driver's line of vision. Check Control data, cruise control functions, and directional arrows from the optional Navigation system can also be displayed. (requires Navigation system)



■ **6-speed manual transmission** delivers a precise, athletic feel. Its responsiveness is due, in part, to the enhanced synchronization of shifts from neutral to each gear. A shortened shift lever and “throw” add to the sporty feel of the gearbox. The sixth gear drops revs at highway speeds for smooth cruising.



□ **Heated rear seats** are a welcome cool-weather feature for left and right rear-seat occupants. With the touch of a button, passengers can individually select their preferred level of warmth. (Must be ordered with Cold Weather Package; not available with Leatherette upholstery.)



□ **Sunshades** in the rear side windows enhance passenger privacy, while reducing sun glare and interior heat.

■ Standard equipment

□ Optional equipment



□ **HD Radio™** receives free, digital AM/FM broadcasts across the U.S. in clear, static-free quality sound – AM sounds like FM; FM sounds like CD. Also enjoy new “multicast” FM stations, as well as a variety of innovative data services.

Can be ordered in combination with optional Logic7 Surround Sound audio system. For more information on HD Radio receivers and to find HD Radio AM/FM stations near you, visit HDRadio.com.



□ **SIRIUS Satellite Radio** delivers nonstop sports, news/talk, entertainment, traffic/weather, and 100% commercial-free music – all day, all night, across the continental U.S. (Optional.)



■ **BMW anti-theft AM/FM stereo CD/MP3 player audio system** with 10 speakers, Auto-Store, and 3-channel FM diversity antenna system.



□ **Logic7 Surround Sound anti-theft AM/FM stereo CD/MP3 player audio system** provides outstanding sound with 13 speakers and the adjustable surround sound function to create a luxurious soundscape all around you. The subwoofer speakers, located under the front seats, produce an authentic bass sound.



■ **Auxiliary input port** lets you connect an external audio source, such as an iPod® or MP3 player.

□ **iPod and USB adaptor** lets you scroll through and select the music you want by using the vehicle's radio controls, the multi-function steering wheel buttons or iDrive Controller. Music titles are displayed on the radio or Navigation screen.

Premium Package: Maximize your driving satisfaction with amenities that provide added comfort and luxury. The 535i xDrive Sports Wagon Premium Package offers supple Dakota Leather seating. For nighttime driving, the automatic-dimming rear-view (interior) and side-view (exterior) mirrors adjust to reduce glare. The Universal garage-door opener offers the convenience of three remote-control functions outside the vehicle, such as opening electronically activated garage doors, or activating home-lighting systems.



Automatic tailgate opener lets you open the tailgate at the touch of a button while sitting comfortably inside. When picking up passengers with luggage, bags, etc., this handy feature lets them access the cargo area without your having to get out of the vehicle – something you'll appreciate on rainy days.



Exterior power-folding side-view mirrors automatically dim when reflecting bright lights, helping to eliminate glare when driving at night.



Automatic-dimming rear-view mirror senses the bright headlights of vehicles behind you, and automatically darkens.



BMW Universal garage-door opener takes the place of up to three remote-control devices. It can activate remote functions outside the vehicle, such as garage-door openers or home-lighting systems.



Dakota Leather upholstery cradles driver and passengers in soft, gathered comfort. Durable and easy to maintain, a leather interior adds elegance and refinement. (Cream Beige Dakota Leather with Dark Poplar Wood interior trim shown)

Cold Weather Package: Enjoy winter to the fullest with the Cold Weather Package. There's nothing like the feel of quick-warming seats and a heated steering wheel on a cold morning. At night and in inclement weather, you'll see and be seen better, thanks to the high-intensity headlight cleaning system. And the addition of a ski bag provides a practical and convenient method for transporting your skis or other long objects by keeping them clean and secure.



Retractable high-intensity headlight washers help keep lights clear of ice, mud, road salt and other coatings, for maximum road lighting and enhanced driving safety.



Heated steering wheel makes gloves unnecessary for cold weather driving. A flick of the switch quickly warms the steering wheel to the perfect temperature.

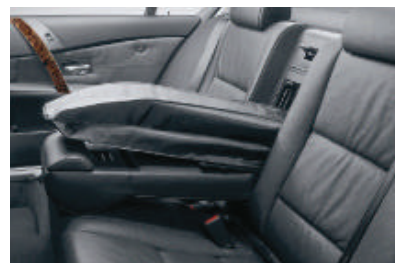

Ski bag allows clean and secure transport of up to four pairs of skis and ski poles. When not extended for use, the ski bag can be stored in the seat, and the center armrest can be left down for use, or folded up to create a third seat.



Heated front seats are a welcome feature for driver and front passenger in cooler weather. With the touch of a button, seat surface and backrest are heated and quickly radiate comfortable warmth in your choice of three settings. (Heated front seats are also available as a stand-alone option; not available with Leatherette upholstery.)

Sport Package¹: The 535i xDrive adds a dynamic edge to the Sports Wagon's look and performance, thanks to shadowline exterior trim, a three-spoke leather-wrapped multi-function sport steering wheel, and 20-way power multi-contour front seats. When selecting the 535i xDrive Sport Package, larger 18 x 8.0 Star Spoke (Style 124) alloy wheels with 245/40 run-flat performance tires² are available as an option.

¹Sport Package requires optional Leather upholstery or Premium Package.

²Due to low-profile tires, please note: wheels, tires and suspension parts are more susceptible to road hazard and consequential damages. Performance tires not recommended for driving in ice and snow. Spare is a space-saver wheel and tire.



Shadowline trim gives a sporty look to front and rear side-window frames, window recess finishers, and door-sill trim strips.



3-spoke leather-wrapped multi-function sport steering wheel lets you keep both hands on the wheel while adjusting various comfort functions, such as radio stations, CD selections and volume.

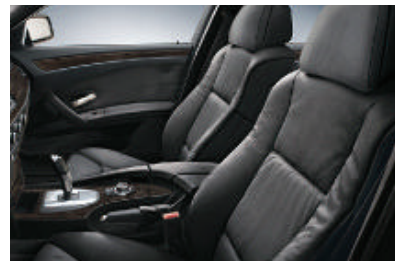

20-way power multi-contour front seats¹ provide optimum lateral support during tight cornering, while remaining exceptionally comfortable when driving over long distances. In addition to active head restraints, the seats offer individual power adjustment for backrest and seat-bottom angle; forward/backward and up/down position; thigh, upper back and lumbar support; and adjustable sides.

¹Multi-contour seats are also available as a stand-alone option, and require optional Dakota Leather upholstery or Premium Package.

	535i xDrive
--	--------------------

	535i xDrive
--	--------------------

Performance and efficiency	
3.0-liter dual overhead cam (DOHC), 24-valve inline turbocharged 300-horsepower 6-cylinder engine with twin-turbo technology, piezo direct injection, and Double-VANOS steplessly variable valve timing	●
Direct ignition system with knock control	●
Electronically controlled engine cooling (map cooling)	●
6-speed manual transmission	●
6-speed STEPTRONIC automatic transmission with Sport and Manual shift modes and Adaptive Transmission Control (ATC)	▲

Comfort and convenience	
Automatic climate control with separate left/right temperature and air distribution controls, with automatic air recirculation	●
Micro-filter ventilation system with replaceable active charcoal filters	●
Panoramic moonroof with fully automatic, two-piece glass panel, power slide and lift control, trap release, wind deflector and power interior sunshade	●
Automatic tilt-down of passenger's side-view mirror (when car is shifted into reverse gear)	●
Automatic tailgate operation	◇
Power tilt and telescopic steering wheel with automatic tilt-up	●
Power windows with key-off and "one touch" up and down operation both front and rear, anti-trapping feature, opening from remote, and closing from exterior lock	●
Manual rear side-window sunshades with 2 shade sections per door	○
Keyless entry with multi-function remote control	●
Comfort Access keyless entry with multi-function remote control	○
Interior courtesy lights with automatic-dimming function	●
Front map lights and rear reading lights with separate controls for the left and right	●
Automatic-dimming interior rear-view mirror and power-folding exterior side-view mirrors	◇
Dual front sun visors with illuminated mirrors	●
Dual cupholders in front and rear	●
3-stage heated front seats ³	○/★
2-stage heated rear seats ⁴	○
Heated steering wheel	★
Fully finished cargo area with tool kit and interior tailgate release	●
Integrated 3-button Universal garage-door opener	◇
Storage area under the cargo floor with adjustable dividers	●
Power outlet in front passenger's footwell, back of center console, and in cargo area	●
Glove compartment with rechargeable take-out flashlight	●
Ski bag	★

Handling, ride and braking	
Aluminum double-pivot-type front suspension	●
Aluminum 4-link integral rear suspension	●
Front and rear anti-roll (stabilizer) bars	●
Aluminum front and rear subframes	●
Twin-tube gas-pressure shock absorbers	●
4-wheel ventilated anti-lock disc brakes (ABS) with Dynamic Brake Control (DBC)	●
Vehicle-speed-sensitive variable-assist (Servotronic), variable-ratio power steering	●
Dynamic Stability Control (DSC), including Brake Fade Compensation, Start-off Assistant, Brake Drying, and Brake Stand-by features; with Dynamic Traction Control (DTC)	●
xDrive all-wheel-drive system	●
Hill Descent Control (HDC)	●

Exterior and aerodynamics	
17 x 7.5 V Spoke (Style 277) alloy wheels, 225/50 all-season tires ¹	●
18 x 8.0 Star Spoke (Style 124) alloy wheels, 245/40 run-flat performance tires ²	○
Xenon Adaptive Headlights with dynamic auto-leveling, Cornering Lights function and Corona headlight-rings	●
Automatic headlight control	●
High-beam Assistant	○
Halogen free-form foglights	●
High-pressure retractable headlight cleaning system	★
Low-liftover tailgate with separately opening rear window	●
Roof rails	●
Rear-window wiper/washer	●
Park Distance Control (front and rear) with graphic display	○
Rain-sensing windshield wipers with adjustable speed	●
Power-adjustable, heated, body-color side-view mirrors	●
Metallic paint	▲
Chrome Line exterior trim	●
Shadowline exterior trim	□

● Standard
 ◇ Included in optional Premium Package
 ○ Optional
 □ Included in optional Sport Package
 ▲ No-cost option
 ★ Included in optional Cold Weather Package

Interior seating	
Leatherette upholstery	●
Dakota Leather upholstery and door trim	○/◇
10-way power front seats with power head restraints	●
4-way power lumbar support for front seats	●
20-way power multi-contour front seats (includes articulated upper backrest, passenger's-seat memory, Active Head Restraints, and adjustable side and thigh support) ³	○/□
Memory system for driver's seat, side-view mirrors, and steering wheel position	●
Open storage compartments in all doors and front seatback storage	●
Adjustable front center armrest	●
Dual center console compartments with provision for phone handset	●

¹Spare is a space-saver wheel and tire.
²Requires Sport Package; due to low-profile tires, please note: wheels, tires and suspension parts are more susceptible to road hazard and consequential damages. Performance tires not recommended for driving in ice and snow. Spare is a space-saver wheel and tire.
³Requires Dakota Leather upholstery or Premium Package.
⁴Requires Cold Weather Package; also requires Dakota Leather upholstery or Premium Package.

	535i xDrive
--	--------------------

	535i xDrive
--	--------------------

Instrumentation and controls	
3-spoke leather-wrapped multi-function steering wheel with controls for audio system, cruise control, and Bluetooth [®] wireless communication for hands-free mobile phone ⁵	●
3-spoke leather-wrapped multi-function sport steering wheel with controls for audio system, cruise control, and Bluetooth [®] wireless communication for hands-free mobile phone ⁵	□
Electronic analog speedometer and tachometer and LCD main and trip odometers	●
Check Control vehicle monitor system	●
Start/Stop button	●
Head-up Display (HUD) ⁶	○
Night Vision ⁷	○
iDrive system with on-board computer and Controller, and 6 programmable memory buttons	●
Exterior temperature display with alarm for freezing temperatures	●
Active Cruise Control (ACC) with Stop & Go ⁸	○
BMW Navigation system with Voice Command System and Real Time Traffic Information	○
Vehicle & Key Memory	●
Tire Pressure Monitor	●

Audio system	
Anti-theft AM/FM stereo/CD audio system with 10 speakers, Auto-Store, FM diversity antenna system, and MP3 capabilities	●
Logic7 sound system with 13 speakers, Surround Sound, and Digital Sound Processing (including 2 subwoofers)	○
iPod [®] and USB adaptor (includes cable connector)	○
6-disc CD changer mounted in glove compartment	△
Auxiliary audio input	●
HD Radio [™] with "multicast" FM station reception	○
SIRIUS Satellite Radio with one-year subscription ⁹	○/△

- Standard
- ◇ Included in optional Premium Package
- Optional
- Included in optional Sport Package
- ▲ No-cost option
- ★ Included in optional Cold Weather Package
- △ Dealer-installed accessory

Safety and security	
Driver's and passenger's front airbag supplemental restraint system (SRS) with advanced technology: dual-threshold, dual-stage deployment; and front-passenger seat sensors designed to prevent unnecessary airbag deployment	●
Front- and rear-seat Head Protection System	●
Front side-impact airbags	●
Rear-seat side-impact airbags and automatic pretensioners on rear outboard safety belts	○
Lane Departure Warning feature that alerts the driver of an improper lane-changing maneuver ¹⁰	○
Front safety belts with automatic pretensioners	●
Active Head Restraints in front seats	●
Automatic locking retractors (ALR) on all passenger-seat safety belts (for installation of child-restraint seats)	●
Interlocking door anchoring system to help protect against door intrusion in side impacts	●
BMW's Advanced Safety System for integrated deployment of safety features	●
Impact sensor that activates Battery Safety Terminal disconnect of alternator, fuel pump and starter from battery; and turns on hazard lights, interior lights and unlocks doors	●
Coded Driveway Protection – a feature that constantly changes the electronic key/ignition code; prevents the engine from starting without using the right key	●
Remote keyless entry security alarm system with selective unlocking and double-lock feature (programmed at BMW center), remote trunk opening, interior motion detector, and panic feature	●
Adaptive Brake Lights	●
BMW Assist [™] with Bluetooth wireless technology for hands-free calling (with Bluetooth compatible mobile phone ¹¹), phonebook downloading and speech recognition capabilities	●

BMW Services	
BMW Ultimate Service [™]	●

⁵If so equipped.
⁶Requires Navigation system.
⁷Requires Navigation system and Cold Weather Package.
⁸Requires STEPTRONIC automatic transmission. Active Cruise Control is not a substitute for the driver's own responsibility in adjusting speed and otherwise controlling the vehicle. After evaluating the road, traffic and visibility conditions, the driver decides whether and how the system is used.
⁹Please visit your authorized BMW center for details on equipment and services requirements.
¹⁰Requires Premium Package. Requires clearly definable lane markings that are not obscured by rain, snow, etc. Lane Departure Warning feature is not a substitute for the driver's own responsibility in maintaining safe control of the vehicle.
¹¹Please contact your authorized BMW center or visit bmwusa.com for a list of BMW-approved **Bluetooth** enabled mobile phones.

	535i xDrive
--	--------------------

	535i xDrive
--	--------------------

Premium Package	
Dakota Leather upholstery and door trim	○/◇
Integrated 3-button Universal garage-door opener	◇
Automatic-dimming interior rear-view mirror and power-folding exterior side-view mirrors	◇
Automatic tailgate operation	◇

Sport Package¹⁴	
3-spoke leather-wrapped multi-function sport steering wheel with controls for audio system, cruise control, and Bluetooth wireless communication for hands-free mobile phone ⁵	□
20-way power multi-contour front seats (includes articulated upper backrest, passenger's-seat memory, Active Head Restraints, and adjustable side and thigh support)	○/□
Shadowline exterior trim	□

Cold Weather Package	
3-stage heated front seats ¹⁴	○/★
Heated steering wheel	★
High-pressure retractable headlight cleaning system	★
Ski bag	★

- Standard
- ◇ Included in optional Premium Package
- Optional
- Included in optional Sport Package
- ▲ No-cost option
- ★ Included in optional Cold Weather Package
- △ Dealer-installed accessory

Stand-alone optional equipment	
6-speed STEPTRONIC automatic transmission with Sport and Manual shift modes and Adaptive Transmission Control (ATC)	▲
18 x 8.0 Star Spoke (Style 124) alloy wheels, 245/40 run-flat performance tires ¹⁵	○
Park Distance Control (front and rear) with graphic display	○
Dakota Leather upholstery and door trim	○/◇
Light Poplar Wood interior trim	▲
Bamboo Wood interior trim	▲
20-way power multi-contour front seats (includes articulated upper backrest, passenger's-seat memory, Active Head Restraints, and adjustable side and thigh support) ¹⁴	○/□
Manual rear side-window sunshades with 2 shade sections per door	○
Comfort Access keyless entry with multi-function remote control	○
3-stage heated front seats ¹⁴	○/★
2-stage heated rear seats ¹⁶	○
Logic7 sound system with 13 speakers, Surround Sound, and Digital Sound Processing (including 2 subwoofers)	○
iPod and USB adaptor (includes cable connector)	○
HD Radio™ with "multicast" FM station reception	○
SIRIUS Satellite Radio with one-year subscription ⁹	○
High-beam Assistant	○
Head-up Display (HUD) ⁶	○
Night Vision ⁷	○
Active Cruise Control (ACC) with Stop & Go ⁸	○
BMW Navigation system with Voice Command System and Real Time Traffic Information	○
Rear-seat side-impact airbags and automatic pretensioners on rear outboard safety belts	○
Lane Departure Warning feature that alerts the driver of an improper lane-changing maneuver ¹⁰	○

¹⁴ Requires Dakota Leather upholstery or Premium Package.

¹⁵ Requires Sport Package; due to low-profile tires, please note: wheels, tires and suspension parts are more susceptible to road hazard and consequential damages. Performance tires not recommended for driving in ice and snow. Spare is a space-saver wheel and tire.

¹⁶ Requires Cold Weather Package; also requires Dakota Leather upholstery or Premium Package.

	535i xDrive
--	--------------------

	535i xDrive
--	--------------------

Weight		
Unladen		
Manual transmission	lbs	4101
STEPTRONIC automatic transmission	lbs	4145
Weight distribution, front/rear		
Manual transmission	%	49.2/50.8
STEPTRONIC automatic transmission	%	49.2/50.8

Performance		
Drag coefficient	C _d	0.33
Top speed ¹	mph	150
Acceleration 0–60 mph ²		
Manual transmission	sec	5.7
STEPTRONIC automatic transmission	sec	5.8

Engine		
Liter/type		3.0/inline 6
Bore/stroke	inch	3.31x3.53
Nominal output/rpm	hp	300/5800
Max. torque/rpm	lb-ft	300/1400-5000
Compression ratio	:1	10.2
Fuel grade		unleaded premium

Fuel consumption³		
Manual transmission		
City/highway	mpg	16/23
STEPTRONIC automatic transmission		
City/highway	mpg	16/24
Fuel capacity	gal	18.5

Transmission		
Manual gear ratios		
	I/II/III :1	4.06/2.40/1.58
	IV/V/VI/R :1	1.19/1.0/0.87/3.68
	Final drive ratio :1	3.08
STEPTRONIC automatic gear ratios		
	I/II/III :1	4.17/2.34/1.52
	IV/V/VI/R :1	1.14/0.87/0.69/3.40
	Final drive ratio :1	3.48

Tires and wheels		
Tire dimensions	standard	225/50
Wheel dimensions	standard	17x7.5
Material	standard	alloy

Brakes		
Front – diameter	in	13.7
Rear – diameter	in	13.6

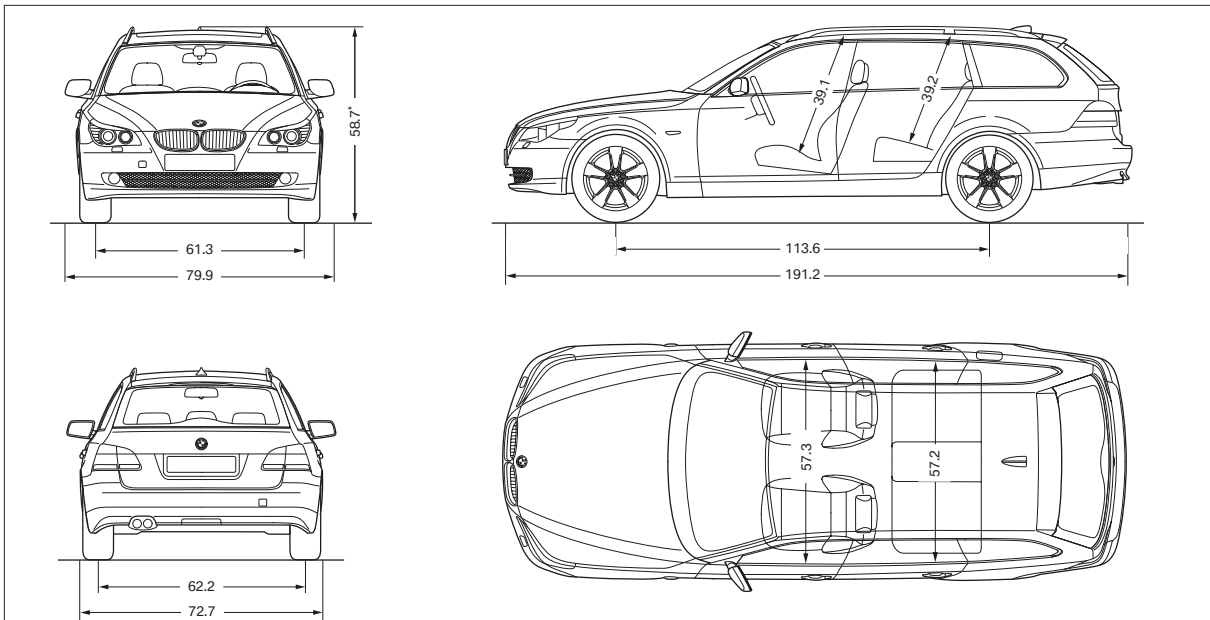

Illustrations above: All dimensions in inches. *Includes height of roof rails and antenna.

¹ Top speed limited electronically.

² BMW AG test results. Actual acceleration results may vary, depending on specification of vehicle; road and environmental conditions; testing procedures and driving style. These results should be used for comparison only and verification should not be attempted on public roads. BMW urges you to obey all posted speed laws and always wear safety belts.

³ EPA-estimated figures are for comparison purposes only. Your actual mileage will vary, depending on speed, driving habits, trip length and driving conditions; actual mileage will most likely be lower.