

Install Manual

(QPI-BM 09)

Update Date	2014.10.27
Model	QPI-BM09-1402-011
Firmware Date	

Warning / Caution



Warning

- When installing the main unit, do not remove or alter existing vehicle fasteners, including nuts, bolts, screw, clips, and fittings. Never detach, move or alter existing vehicle wiring, including electrical grounds and straps. Alteration of existing vehicle components may make vehicle unsafe to operate. Should be no any electronic devices or magnetic pole around installation place.
- Air bags are vital part of a safety system. Never install main unit in a way which will alter air bag wiring or interfere with air bag deployment. Air bags must function properly in the event of an accident.
- Before installing, check the location of pipe, tank, electrical cables and others.
- Read and follow the instruction manual.
- Wiring location must not interfere driving, get in or out from car.
- Use electrical tape to insulate the ends of all wires, even if they are not used. Proper insulation prevents arcs, shocks and fires.
- When installation is complete, test all vehicle electrical systems to ensure they operate correctly, including lights, horn, brake lights, and emergency flashers.
- According to our sales policy, any problems caused by user's mistake, careless can not be guaranteed.



Caution

- All steps of installation should be done by well-trained specialist.
- During installation ignition key should be taken off and after all installation finish connect power cable with interface for the last step.
- Do not install the main unit in places where it ma be exposed to dew condensation (around the air conditioning hose, etc), or in locations where it may come in contact with water, high levels of moisture, dust or oily smoke
- Install wiring in a manner in which cables will not come in contact with metal parts. The wiring may be damaged by contact with metal parts, resulting in fire and shocks. Avoid all contact with hot surfaces when wiring the main unit. High temperatures may damage wiring, causing shorts, arcing and fires.
- Kindly check all parts are in the box, when receiving the product, if anything missing, inform to the supplier or manufacturer.

Table of Contents

1. Specifications	
1.1 Main Specifications	4
1.2 Features	5
1.3 System Diagram	6
1.4 Components	7
1.5 Exterior	9
2. Installation	
2.1 Installation Diagram.....	10
2.2 Installation	11
3. Settings	
3.1 DIP Switch	13
3.2 Remote Control	14
3.3 Car Model and Navi Model.....	15
3.4 Factory Mode.....	16
3.5 DVD, DTV I-DRIVE input	19
3.6 Original Button Usage	21
3.7 Rear Camera	22
3.8 Rear Parking Guidelines	24
3.9 OSD	25
4. Trouble Shooting	27

1. Specifications

1.1 Main Specifications

1. Compatibility

Most of brand-new cars coming with CIC Navigation Computer System including BMW 5 series

2. Product composition

Multimedia Interface * 1 ea

3. MULTIMEDIA INTERFACE input spec.

3 * A/V input (external video input)

1 * CVBS input (rear camera source input)

1 * RGB input (navigation system & HDMI)

1 * LCD input (car system input)

4. MULTIMEDIA INTERFACE output spec.

1 * LCD output

5. POWER spec.

input power : 8VDC ~ 18VDC

consumption power : 5 WATT

6. Switch input mode

- Input video skip function : able to select whether to use the respective input video sources or not via DIP switch.
- Able to change input modes via the remote control.
- Able to detect rear camera via CAN or rear lamp cable.
- Able to change modes via an OEM Button

1. Specifications

1.2 Features

- Able to control NAVI, DVD, DTV function via Multimedia Touch GUI
- Able to adjust external image (DVD, NAVI) display on screen
- Improved Screen Display (user-oriented interface)
- Mode change through original button
- Provide power cables to connect with rear camera
- Dynamic PAS(Parking assistance system)

1. Specifications

1.3 System Diagram

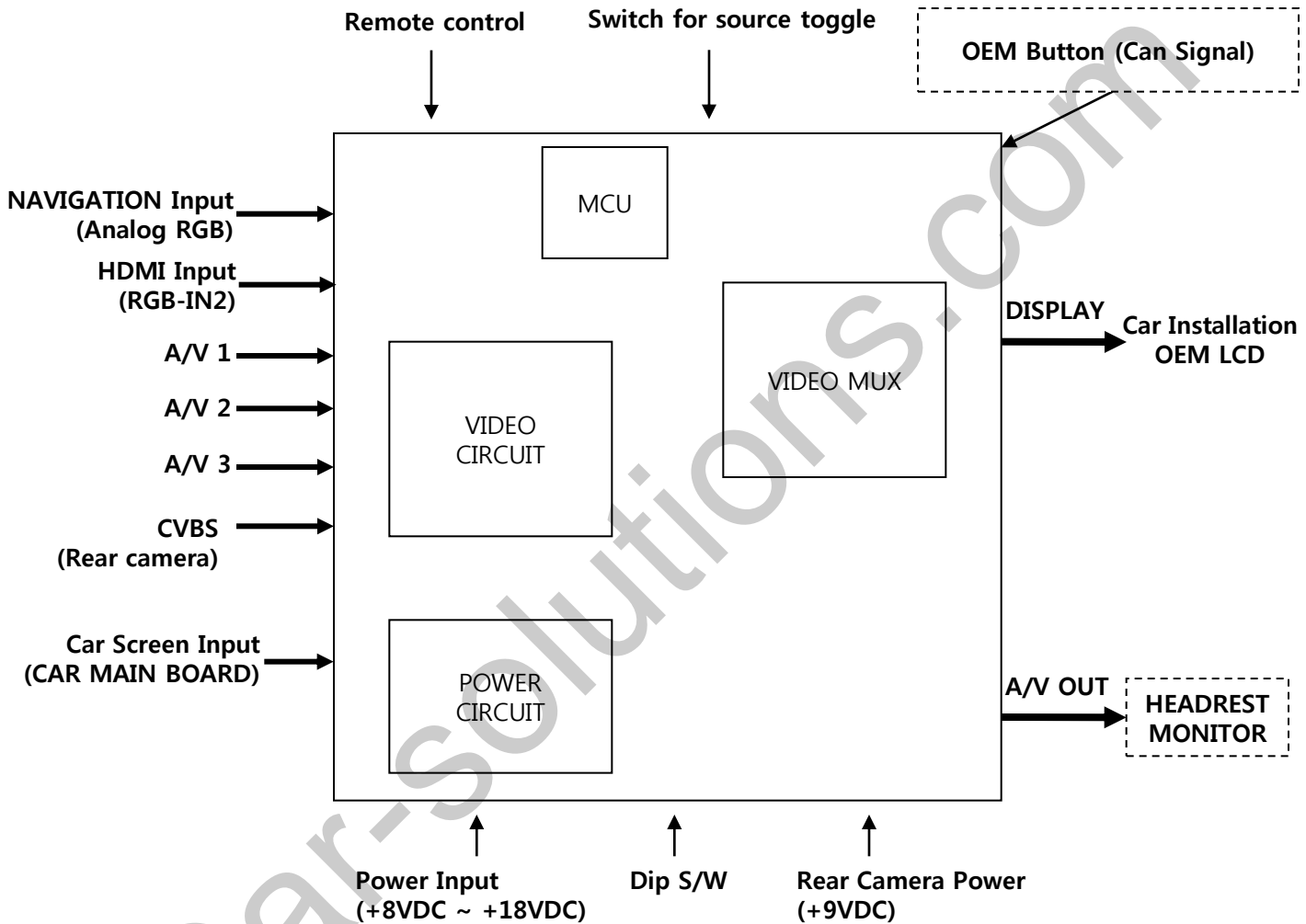

1. Specifications

1.4 Components

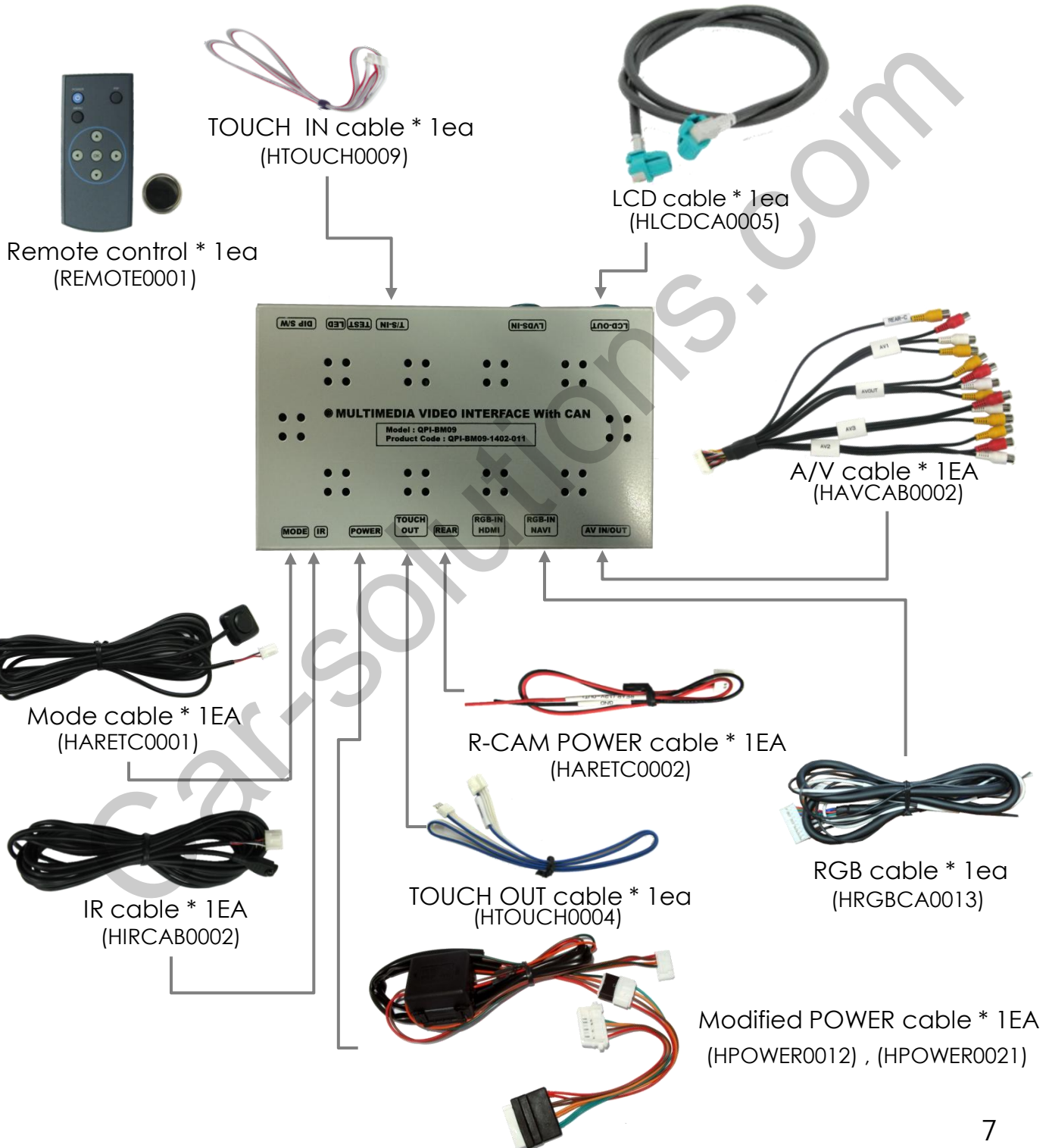

1. Specifications

1.4 Components



6.5" Touch Panel
(TOUPAN0003)



8.8" Touch Panel
(TOULCD0011)

1. Specifications

1.5 Exterior

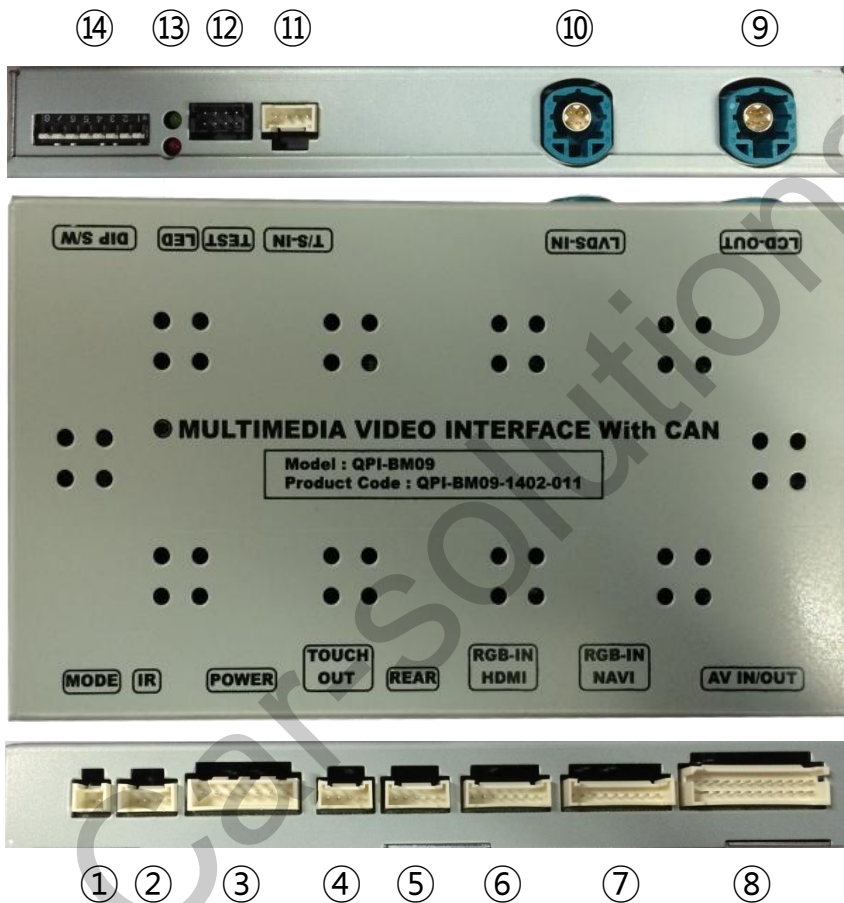

Dimension

Width 150.4mm
Length 99.4mm
Height 2.3.2mm

- ① MODE
- ② IR
- ③ POWER
- ④ TOUCH OUT
- ⑤ REAR
- ⑥ RGB-IN HDMI
- ⑦ RGB-IN NAVI
- ⑧ AV IN/OUT
- ⑨ LCD-OUT
- ⑩ LCD-IN
- ⑪ T/S-IN
- ⑫ TEST
- ⑬ LED
- ⑭ DIP S/W

2. Installation

2.1 Installation Diagram

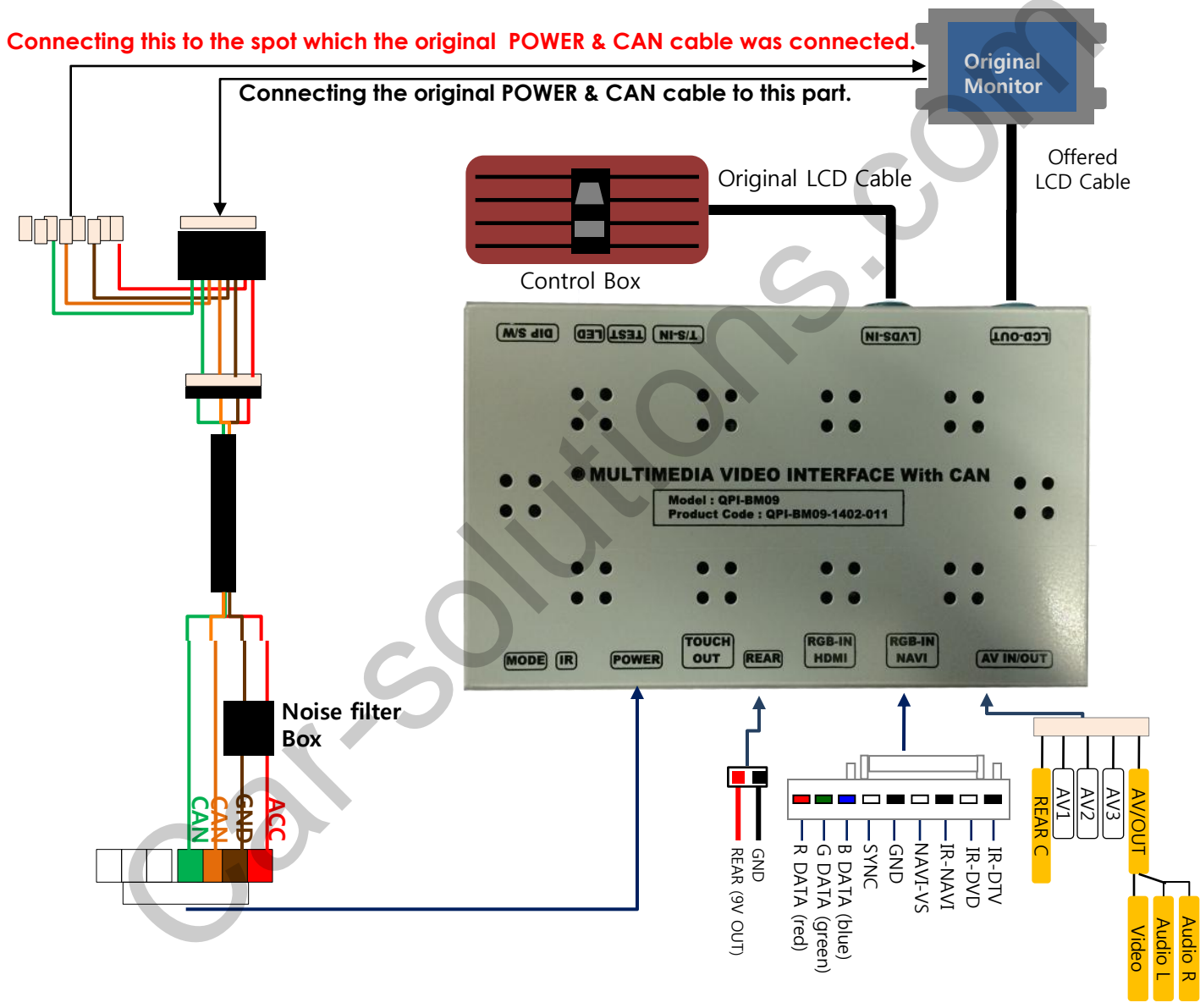

2. Installation

2.2 Installation / Connection of Power cable

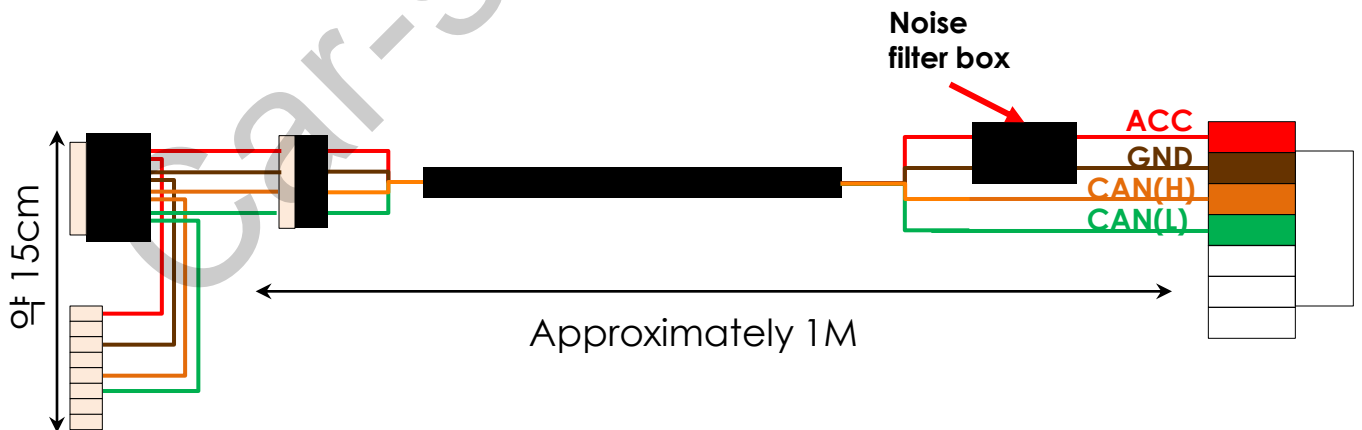
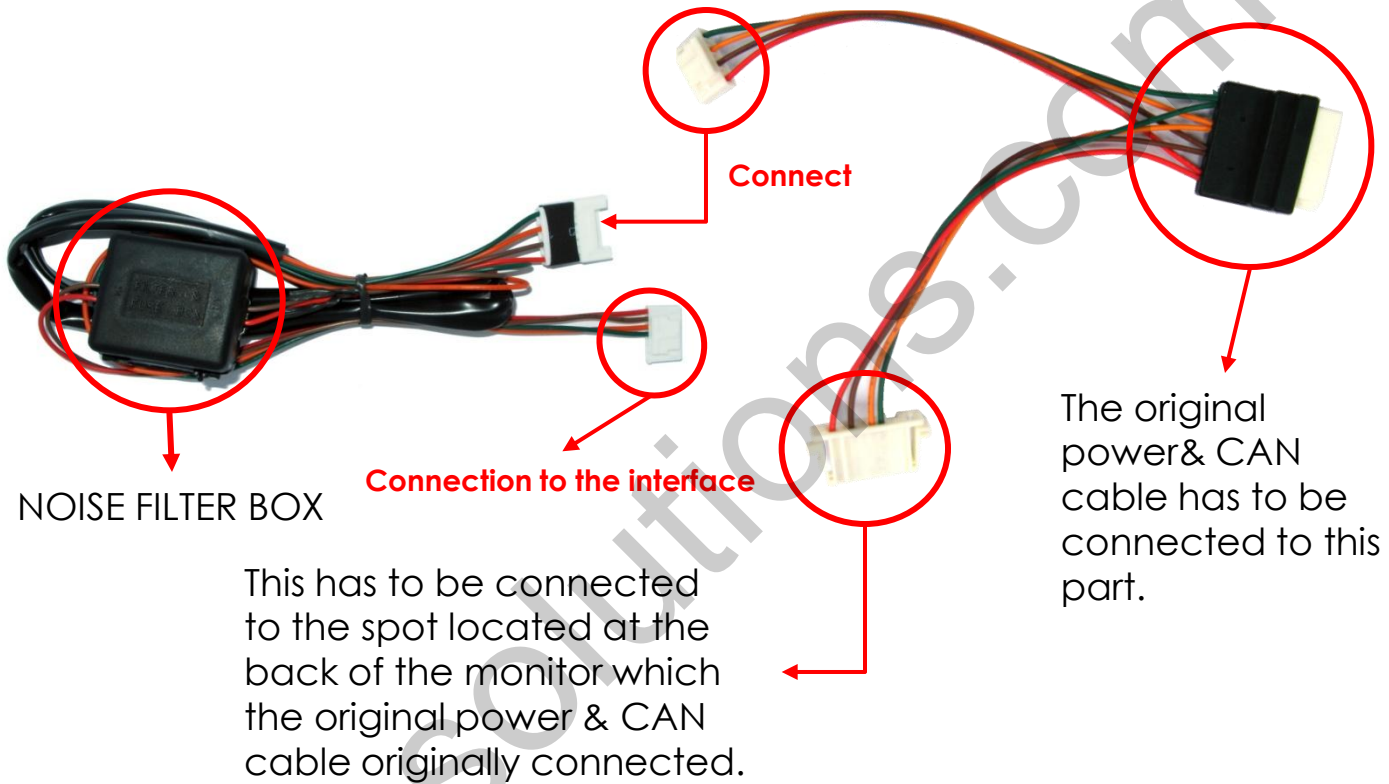

2. Installation

2.2 Installation / Monitor and Interface connection

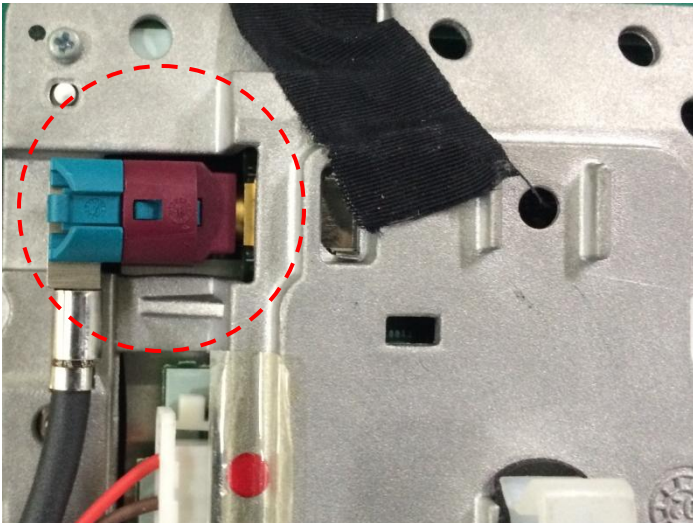

- ① See left picture, Remove original LCD cable from monitor and connect with provided LCD cable.



- ② Connect the original LCD cable with LCD-IN on the interface.

※ Precaution : Do not connect power cable with accessory power, connect with backside of command or cigar jack.

3. Settings

3.1 DIP Switch

- ※ Example DIP S/W usage
 - Use input mode : A/V2, A/V3
 - Use original navigation
 - External rear camera

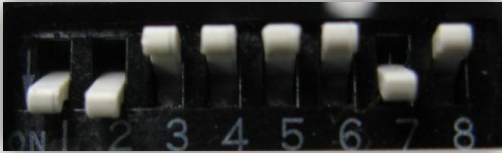

※ ON : DOWN / OFF : UP
Default : DIP S/W 8 OFF

- ▷ DIP S/W : 1,2 → ON (Hide INPUT MODE)
- ▷ DIP S/W : 3 → OFF (A/V2 display)
- ▷ DIP S/W : 4 → OFF (A/V3 display)
- ▷ DIP S/W : 5,6 → OFF
- ▷ DIP S/W : 7 → ON (display external rear cam)
- ▷ DIP S/W : 8 → OFF

<i>PIN</i>	<i>Function</i>	<i>Dip S/W Selection</i>
1	Displaying RGB input	ON : RGB mode skip OFF : RGB mode display
2	Displaying A/V 1	ON : A/V 1 mode skip OFF : A/V1 mode display
3	Displaying A/V 2	ON : A/V 2 mode skip OFF : A/V2 mode display
4	Displaying A/V 3	ON : A/V 3 mode skip OFF : A/V3 mode display
5	Setup of monitor size	ON : 7.2 inch OFF : 10.2 inch
6	Select MINI model	ON : Select MINI car
7	Setup of rear camera use	ON : CVBS4 OFF : MAIN
8	Setting up display image	ON : By MUX (ON:DEFAULT) OFF : By Relay

※ Please make sure to disconnect the power cable of the interface and reconnect the power cable again to apply the dip switch setting whenever changing DIP switch. Otherwise, DIP switch setting will not be applied.

3. Settings

3.2 Remote Control



<i>Key</i>	<i>Function</i>
POWER & PIP	Unavailable
MENU	Activating OSD menu
OK	Making a selection, changing image display
▲	Moving upward
▼	Moving downward
◀	Moving leftward (If you press this button 2 seconds long, you can access the factory mode.)
▶	Moving rightward (If you press this button 2 seconds long, you can reset all the data about user environment.)

3. Settings

3.3 Car Model and Navi Model

FACTORY mode – Press ◀ button 2 seconds long on the remote control.

▪ Setup for car model

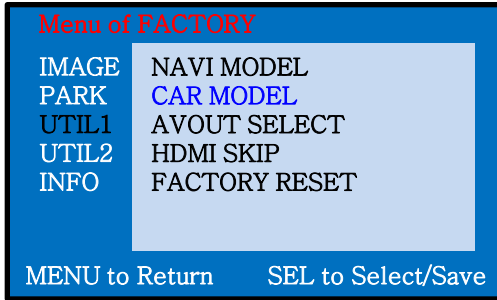

UTIL1 - CAR MODEL

Selecting model of the car

F10 : 5 Series 2009~2012

E90 2014Y : X1 2014~

E90 : No use

*** Set pin#5 of DIP switch to the right size of the monitor after selecting model of the car. (Refer to page9.)**

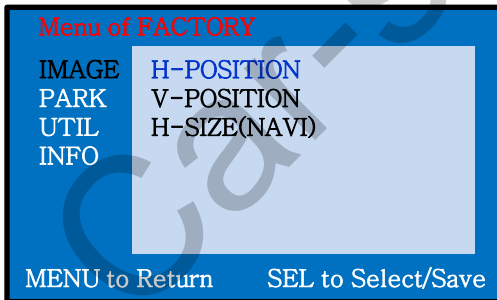

IMAGE

Adjust navigation position and size

H-POSITION : Move display horizontally

V-POSITION : Move display vertically

H-SIZE : Adjust navi size horizontally

▪ Setup for navigation

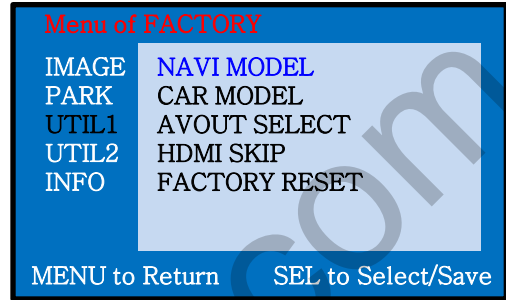

UTIL1 – NAVI MODEL

Select of the navigation Model

DEFAULT

PAPAGO(WVGA)

NAVIST OEM(WVGA)

GN-3000(WVGA)

ICUBE(WVGA)

NAV-506TP(WVGA)

MYVI(WVGA)

WP9200(WVGA)

HDMI(WVGA)

GI-8000N 3D(WVGA)

GI-5000A(WVGA)

A-CLASS(WVGA)

KD-900(WVGA)

PAPAGO(WQVGA)

LS-901(WQVGA)

*** Go into FACTORY/ UTIL1 (as shown right) and adjust the position and the size of the navigation after setting the definition of the navigation**

3. Settings

3.4 FACTORY Mode

FACTORY mode – Press ◀ button 2 seconds long on the remote control.

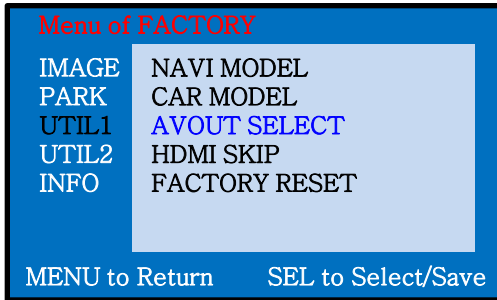

UTIL1 – AVOUT SELECT

Selecting background sound After returning navigation or original mode

DEFAULT : Selecting AV sound just before changing navigation or original mode from the AV mode

AV 1~3 : Sound of the selected AV source 1~3

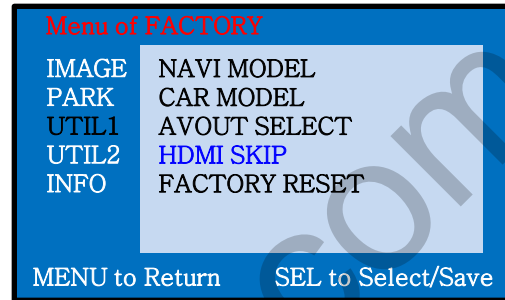

UTIL1 – HDMI SKIP

Selecting the use of HDMI mode ON / OFF



UTIL1 - FACTORY RESET

- Reset

※ Long press the ▶ button

3. Settings

3.4 FACTORY Mode

FACTORY mode – Press ◀ button 2 seconds long on the remote control.

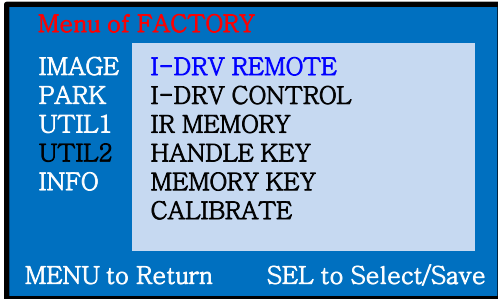

UTIL2 - I_DRV REMOTE

Choose DTV and DVD model to be control I_DRV function

- Select DVD model: Setting on AV1 Mode
- Select DTV model : Setting on A/V2 mode

UTIL2 - I_DRV CONTROL

Selecting whether to use I_DRV function or not

ON / OFF

- A/V1 : Control DVD Remote control UI
- A/V2 : Control DTV Remote control UI

3. Settings

3.4 FACTORY Mode

FACTORY mode – Press ◀ button 2 seconds long on the remote control.

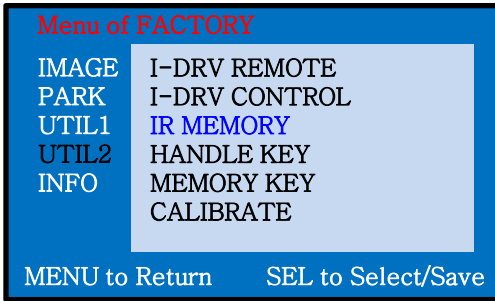

UTIL2 – IR MEMORY

To register DVD, DTV remote control, the remote control value must be registered and can be control with I-Drive
DVD(A/V1), DTV(A/V2)

※ To use this function, in UTIL2-I_DRV REMOTE select USER mode (Connect IR of DVD / DTV to Remote control.



UTIL2 – HANDLE KEY

Whether to use voice button on handle for mode change
ON / OFF



UTIL2 – MEMORY KEY

Whether to use car audio button #8 (mode change + aux change)

ON / OFF

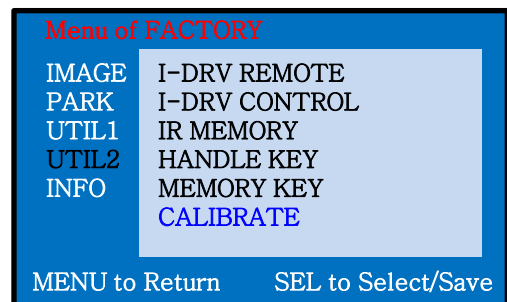

UTIL2 – CALIBRATE

Touch Calibration

YES / NO

3. Settings

3.5 DVD, DTV IR MEMORY input

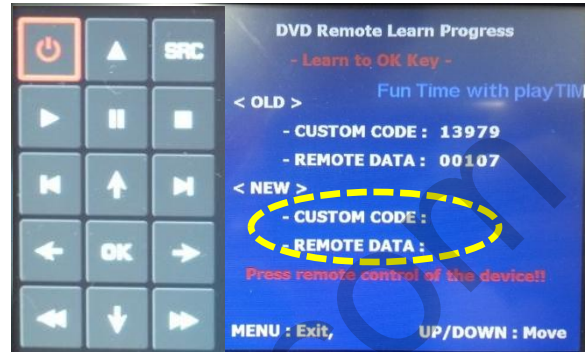
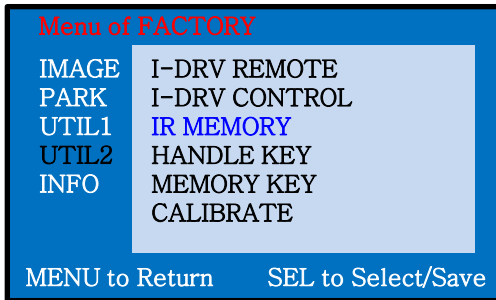

- ① First of all, press ◀ button on remote controller 2 seconds long or press UP→DOWN→UP→MENU button in order to access Factory mode. Choose IR MEMORY on UTIL2.

In IR MEMORY, you can choose AV source of DTV and DVD you want to use.

- ② Picture above shows DVD remote control button value input, select menu you want to save. (To register DVD remote control button value, select IR MEMORY – DTV and follow below instructions.

Example)

- a. After select OK button on OSD menu, press intended I-Drive button
- b. Indicated part above will flicker, and press POWER on DVD remote control.
(continue to next page)

What is IR-MEMORY Mode?

Is to allow I-Drive and touch screen to control other DVD or DTV (besides the existing,; for example : SANYO, NECVOX) by register remote control value.

3. Settings

3.5 DVD, DTV I-DRIVE input



example) continued..

- c. The values that you registered will appear as green text in the marked area on pressing the button. And the values will be saved automatically.
- d. Register remain buttons' value in OSD menu like the above-mentioned.

- ③ After register, select "SRC" button in OSD menu. Then you can see confirmation window as shown above. At the moment, (If data is saved, DVD TYPE and DTV TYPE will be changed to "USER" automatically.)

If you see "SUCCESS" on screen, the data is saved clearly and you can control DVD via touch screen. BUT, you MUST change the option in FACTORY-UTIL2-I_DRV REMOTE to "USER".

- ※ When touch the screen, you can control DVD, DTV using remote control UI via touch screen or I-Drive
(6.5" monitor – Touch the middle of the screen,
8.8", 10.2" monitor – Touch the left side of the screen)
- ※ If touch the screen in DVD(A/V1), DTV(A/V2) mode, Can see remote control UI
If touch the screen in RGB(HDMI), A/V3 mode, Can see mode switching UI
- If you want to see mode switching UI in DVD, DTV mode, Select "SRC" button



3. Settings

3.6 Original Button Usage

I-Drive Button(All models)



<i>Mode</i>	<i>Key</i>	<i>Operation</i>	<i>Function</i>
All modes	MENU	Long Press	Mode change
		Short Press	back to original image
DMB	△	Long Press	Scan Channel
		Short Press	Channel up
	▽	Short Press	Channel down
AV1 AV2 AV3	▽	Long press	Operate PIP Function
Reverse Mode	▽	Long press	Operate PIP Function

Hot Key Function



<i>Mode</i>	<i>Key</i>	<i>Operation</i>	<i>Function</i>
All Modes	# 8 button located beside Radio button	Short Press	Switch modes

3. Settings

3.7 Rear Camera



❑ Setting up the screen option of Rear Image

5 Series(F10) :  Long Press I-Drive to set up



<Full Image of Rear Camera>

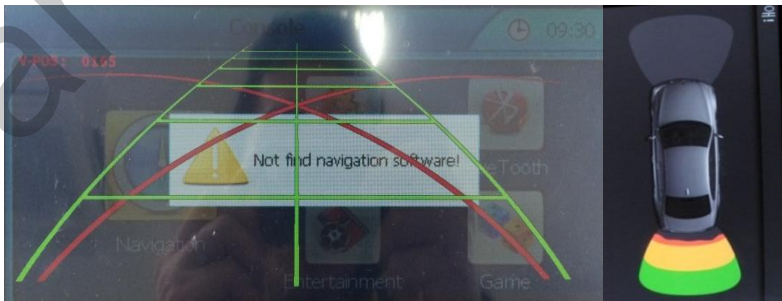

<Rear Camera +PDC >

3. Settings

3.7 Rear Camera

FACTORY mode – Press ◀ button 2 seconds long on the remote control.

※ After installing rear camera : DIP S/W #7 must be put down (ON). Refer to page 9.

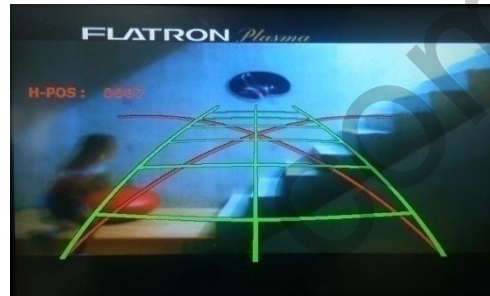
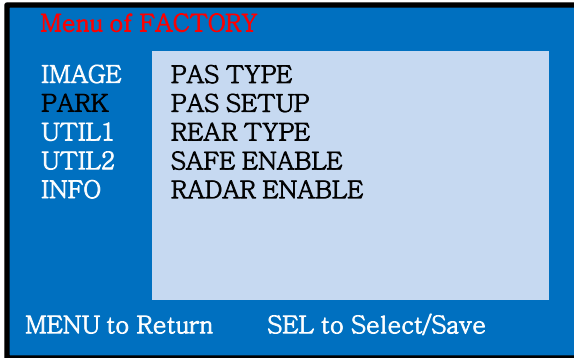

□ PARK

PAS TYPE : Selecting Type of parking guide line

- NOT USED : Not use Parking guide line
- PAS ON : Selecting Dynamic Parking guide line
- PAS OFF : Selecting fixed Parking guide line

PAS SETUP : Adjusting the position of the parking guide line (available in PARK SETUP-> V-POSITION, H-POSITION)

REAR TYPE : Choose rear camera recognition

- * LAMP - Detecting the rear view camera via rear lamp (Installer must connect "Rear-C" cable of the power cable to the rear lamp of the car.)
- * CAN - Detecting the rear view camera by CAN signal (Installer must connect "CAN" cable of the power cable to the "CAN" cable of the car.)

SAFE ENABLE : If your car is connected with CAN cable and it is in "ON" state, you can NOT watch DVD or A/V except original image or navigation while driving. At that time the screen use only main and navigation(default : OFF)

CAMERA TYPE : When PDC mode, Selecting screen ratio

- * OEM CAM : The car has original camera and install external camera
- * EXT. CAM : The car doesn't have original camera and install external camera

a. If you want to get to the FACTORY mode, set the gear as rear state and press "LEFT" button 2 seconds long on the remote control or the keypad. (as shown left top)

3. Settings

3.8 Parking guide Lines

Go to Factory Menu, choose PAS SETUP, by using OK button change H-POS → V-POS

□ H-POS

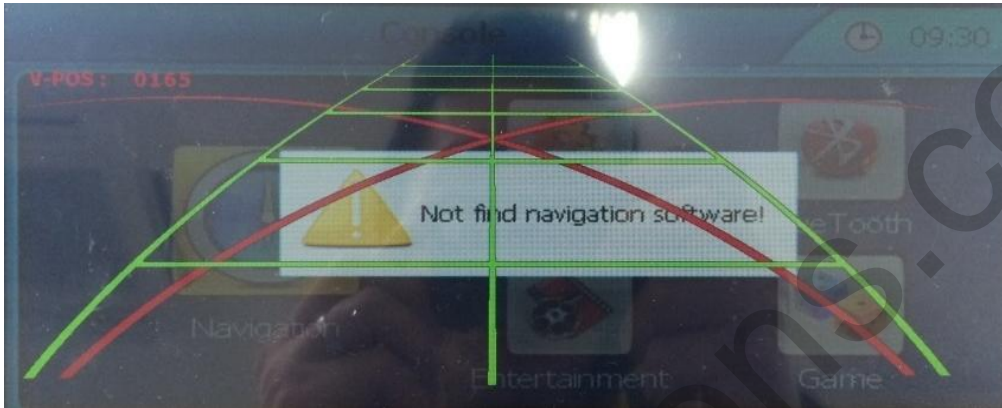

In H-POSITION, use ◀, ▶ on remote control, to adjust parking guideline left and right.

□ V-POS

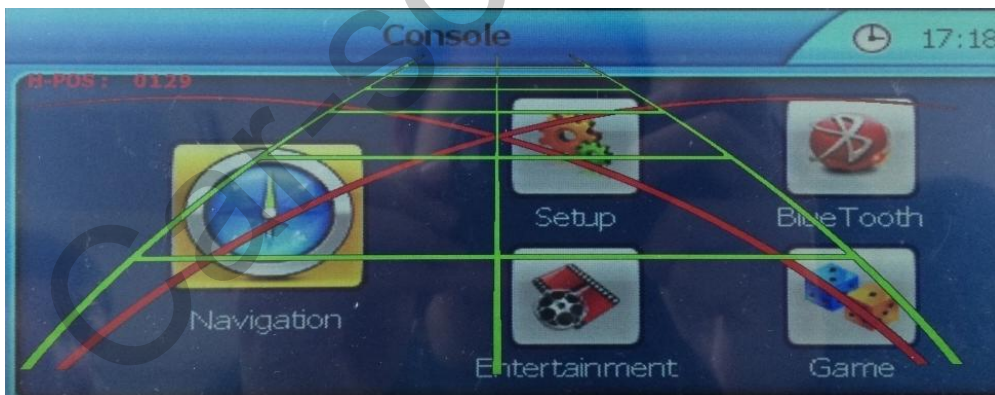

In V-POSITION use ▲, ▼ on remote control, to adjust parking guideline up and down.

3. Settings

3.9 OSD (On Screen Display) / Analog RGB Mode



□ IMAGE

- * BRIGHTNESS
- * CONTRAST
- * SHARPNESS

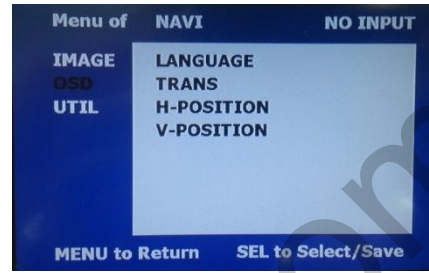

□ OSD

- * LANGUAGE : Set OSD language (only support English and Chinese)
- * TRANS : Adjust OSD transparency
- * H-POSITION : Move OSD horizontally
- * V-POSITION : Move OSD vertically



□ UTIL

- * FACTORY RESET
: Factory reset only for OSD function
(unable reset video position)

3. Settings

3.9 OSD (On Screen Display) / Video Mode



□ IMAGE

- * BRIGHTNESS
- * CONTRAST
- * SATURATION
- * HUE
- * SHARPNESS

□ OSD

- * LANGUAGE : Set OSD language (only support English and Chinese)
- * TRANS : Adjust OSD transparency
- * H_POSITION : Move OSD horizontally
- * V_POSITION : Move OSD vertically

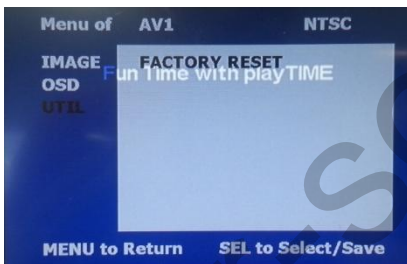

□ UTIL

- * FACTORY RESET
: Factory reset only for OSD function (unable reset video position)

4. Trouble Shooting

Q. I cannot change mode

- A. Check connection of Ground cable and IR Cable.
Check LED lamp is on, if not check connection of POWER cable.

Q. All I got on the screen is black.

- A. .Check second LED lamp of the interface is on, if not, check A/V sources connected are working well.
(Second lamp indicates AV sources connected works well.) Check interface connection has been done well.

Q. Displayed image color is not proper (too dark or unsuitable color)

- A. Try to select "INITIAL" in OSD menu, if it does not work, inform to manufacturer.

Q. I cannot watch the rear camera on the screen

- A. Set the DIP switch #7 as state "ON".

Q. Set mode not appear

- A. Check DIP Switch.

Q. OEM image is not displayed.

- A. Check interface's LCD In/Out cable connection. If the status keeps on, inform to manufacturer.

Q. Screen only displays white color.

- A. Check LCD out cable is connected well, if this status keeps, inform to manufacturer.

Q. Show PIP function via handle button, and original screen appear half only.

- A. This is not because of faulty interface, please check original monitor split function settings.

Q. After connect CAN cable, set gear "R", video doesn't appear.

- A. Go to "FACTORY MODE" and check "UTIL-Rear Select". Change "LAMP" settings to "CAN" with remote control.

※ LAMP : In case of connecting "Rear-C" wire of Power Cable to Rear Lamp in vehicle.

It may not work on a camera with 12V