**Special tools required:**

- 12 1 171
- 12 1 172

*Necessary preliminary tasks:*

- Switch off ignition
- Remove all ignition coils.

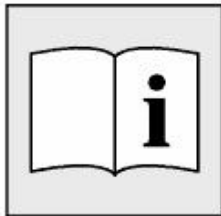
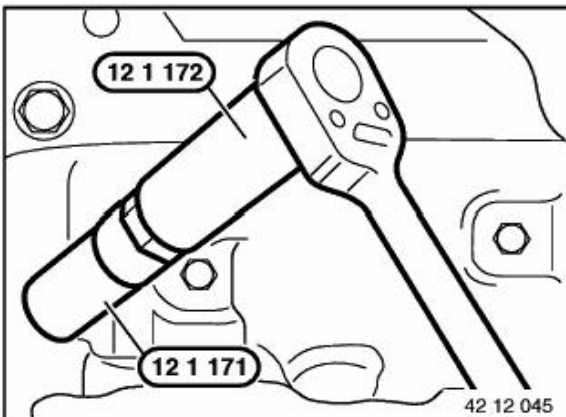

Unscrew spark plugs with special tool 12 1 171 .

Installation:

Tighten down spark plugs with special tool 12 1 171 and special tool 12 1 172 (torque limiter).

Without special tool 12 1 172 , observe tightening torque.
Tightening torque 12 12 1AZ .

Switch off ignition.

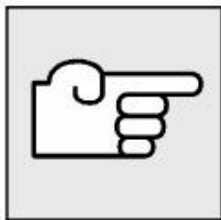

Necessary preliminary tasks:

- Remove acoustic cover.
- BMW ALPINA B7 vehicles:
 - Remove radial compressor.

Pull ignition coil covers (1) out of rubber grommets.

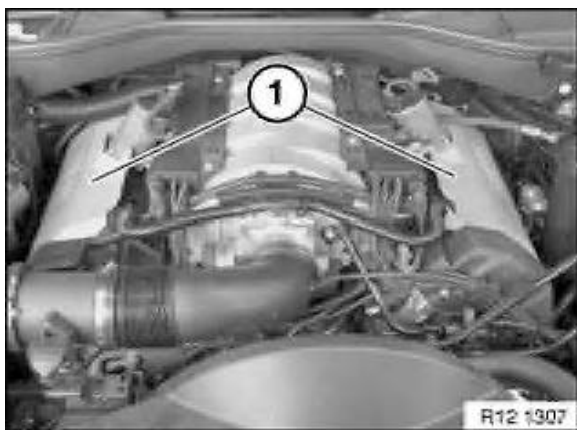

Unlock plug fastener (1) of ignition coil.

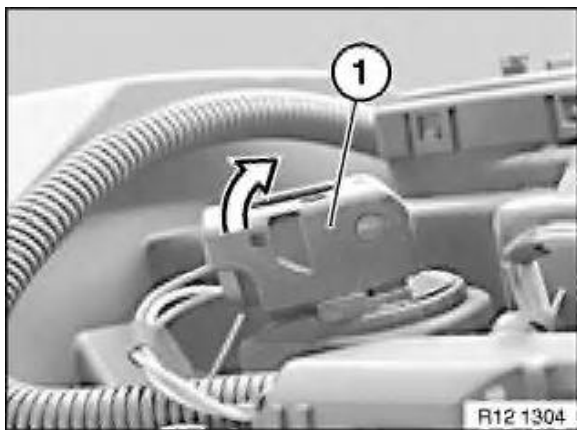

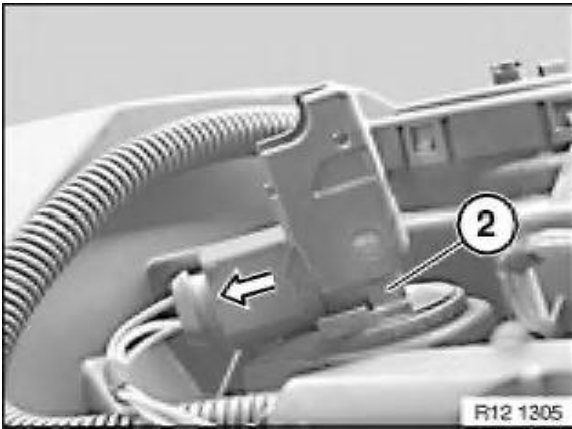

Disconnect plug.

Pull out ignition coil (2).

This procedure is applicable to all ignition coils.

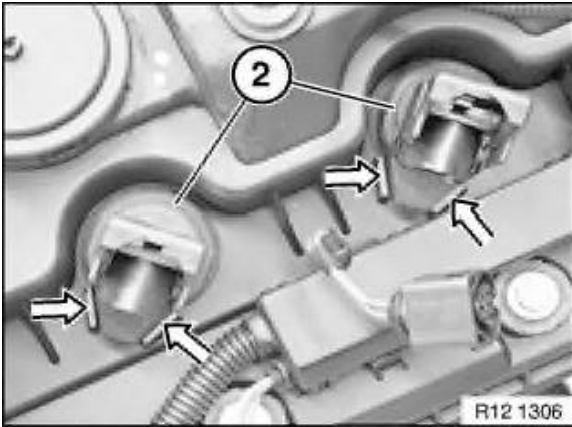

Installation:

Insert rubber seal on ignition coils (2) between guides.

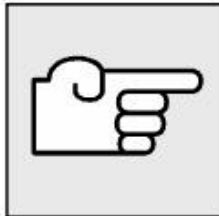

Note:

Read out fault memory of DME control unit.

Check stored fault messages.

Rectify faults.

Now clear the fault memory.

Removing acoustic cover (N62/N62TU)

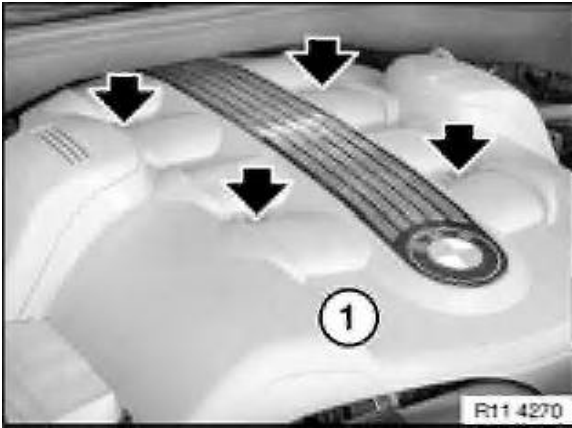

Unfasten screws.

Raise acoustic cover (1) and remove towards front.

12 12 Spark Plugs

	Type	Thread	Tightening specification	Measure
1AZ Spark plugs (ungreased)	All	M12x1.25		23 ± 3 Nm
	All	M14x1.25		30 ± 3 Nm