**Special tools required:**

- 64 1 020

*Necessary preliminary tasks:*

- Remove light operator unit

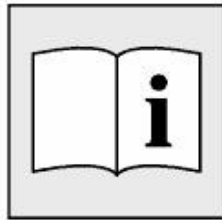
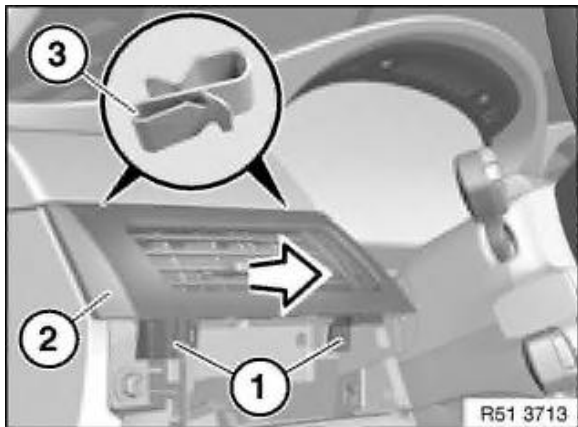

Release screws (1).

Unclip left decorative strip on instrument panel complete with left fresh-air grill (2) at top and remove in direction of arrow.

Installation:

Make sure clips (3) are correctly seated on mountings of left fresh-air grill (2).

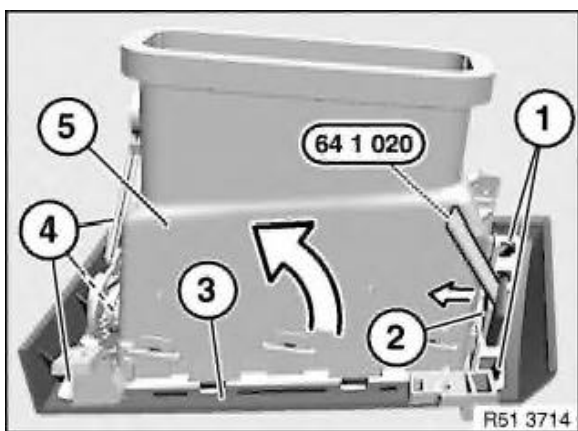
Replacement:

Release lock (2) with special tool 64 1 020 .

Unclip left fresh-air grill (5) in direction of arrow over retaining lugs (1) and remove from left decorative strip on instrument panel (3).

Installation:

Make sure left fresh-air grill (5) is correctly seated in mountings (4) of left decorative strip on instrument panel (3).

Make sure retaining lugs (1) and lock (2) of left decorative strip on instrument panel (3) are correctly seated.

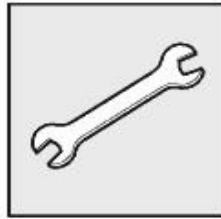
**Special tools required:**

- 64 1 020

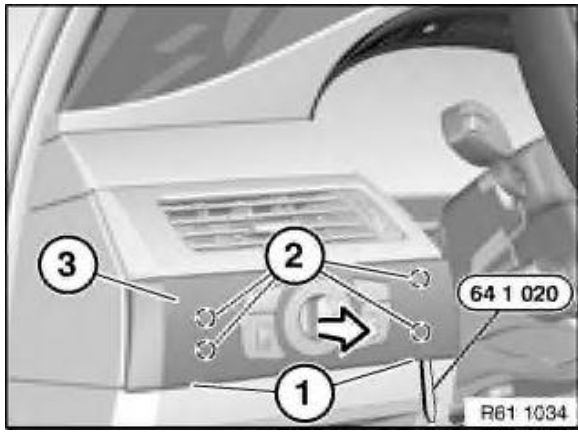

Attach special tool 64 1 020 at openings (1) and lever out catches (2). Pull back lighting control unit (3).

Unlock and disconnect associated plug connection, remove lighting control unit (3).

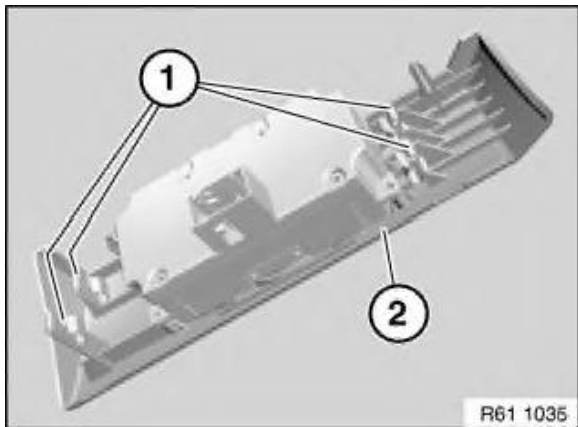
**Installation:**

Make sure clips (1) are correctly seated on trim of lighting control unit (2).

64 1 020

Release hook

Minimum set: Mechanical tools

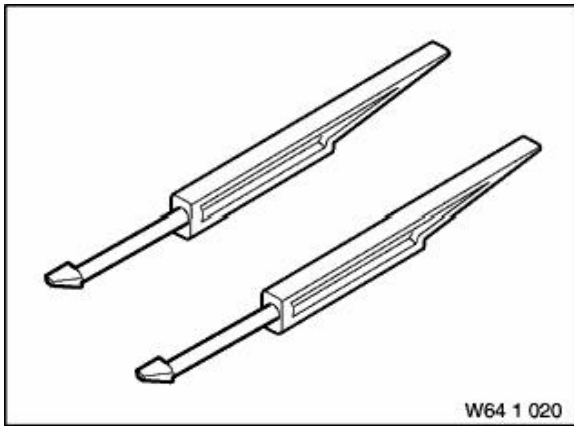

Note:

For releasing and removing fresh-air grills - For lever out various trims - Model series: All models

Series:

E36, E36/2, E36/3, E36/5, E36/7, E36/C, E36tou, E38, E38/3, E39, E39PL, E39tou, E46, E46/16, E46/2, E46/3, E46/5, E46/C, E52, E53, E60, E61, E63, E64, E65, E66, E67, E83, E85, E87, E90, R50, R52, R53, RR1

Storage location:

C33

SI number:

1 15 99(483)

Order number:

64 1 020
Release hook